

Suprema Thermal Camera

SETUP GUIDE

Version 1.02

English

EN 107.00.TCM10-FSF2 V1.02A

Contents

Safety instructions	3
Introduction	4
Components	4
Installation	5
Installing Suprema Thermal Camera on a previously installed FaceStation F2	5
Installing Suprema Thermal Camera on a new FaceStation F2	9
Settings	13
Troubleshooting	15
Checklist before reporting a failure	15
Product specifications*	16
Dimensions.....	17
Appendices	18
Disclaimers	18
Copyright notice.....	18

Safety instructions

Observe the following instructions to use the product safely and prevent any risk of injury or property damage.

Warning

Noncompliance of instructions could lead to serious injury or death.

Installation

Do not install the product in a place with direct sunlight, moisture, dust, or soot.

- A fire or electric shock may occur.

Do not install the product in a place with heat from an electric heater.

- A fire or electric shock may occur due to overheating.

Install the product in a dry place.

- Otherwise, a product damage or electric shock may occur due to moisture.

Install the product in a place with no electromagnetic interference.

- Otherwise, a product damage or electric shock may occur.

The user should not install or repair the product independently.

- A fire, electric shock, or personal injury may occur.
- If the product has been damaged due to independent installation or repair of the product by the user, free A/S service will not be provided.

Operation

Do not allow liquids such as water, beverages, or chemicals get into the product.

- A fire, electric shock, or product damage may occur.

Caution

Noncompliance of instructions could lead to minor injury or product damage.

Installation

Do not install the power supply cable in a place where people pass by.

- Product damage or physical injury may occur.

Do not install the product near a highly magnetic object such as a magnet, TV, (especially CRT) monitor, or speaker.

- A product failure may occur.

Operation

Do not drop the product or apply an impact to the product.

- A product failure may occur.

When cleaning the product, wipe the product with a soft and dry cloth and no water, benzene or alcohol.

- Otherwise, a product failure may occur.

Introduction

Suprema Thermal Camera with FaceStation F2 measures skin temperature of users passing the access point and limit the access of users with a higher temperature than the preset threshold. FaceStation F2 sets the region for temperature measurement from where Suprema Thermal Camera detects the highest value point.

This document describes how to install the FaceStation F2 and Suprema Thermal Camera in combination.

NOTE

- Some details may differ depending on the model you use.

Components

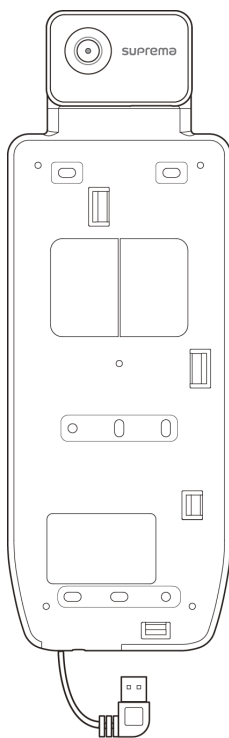

<TCM10-FSF2-ODB>

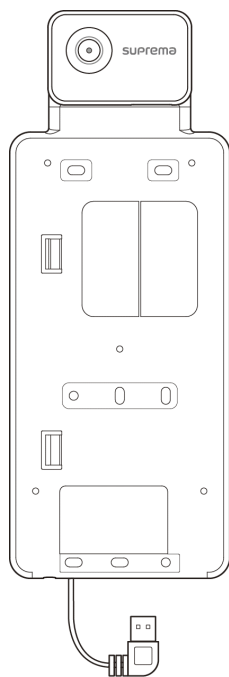

<TCM10-FSF2-DB>

Suprema Thermal Camera

- Suprema Thermal Camera Module
- USB Cable
- Bracket

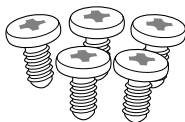

Bracket Fixing Screw x5

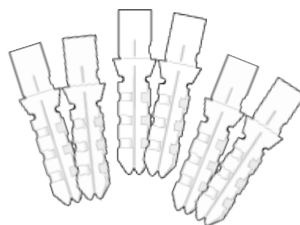

PVC Anchor x6



Fixing Screw x6

NOTE

- FaceStation F2 is sold separately. For more details, visit the Suprema website (www.supremainc.com) and refer to the user manual.

Installation

Installing Suprema Thermal Camera on a previously installed FaceStation F2

- 1 Loosen the bracket fixing screw to separate the FaceStation F2 and the bracket.

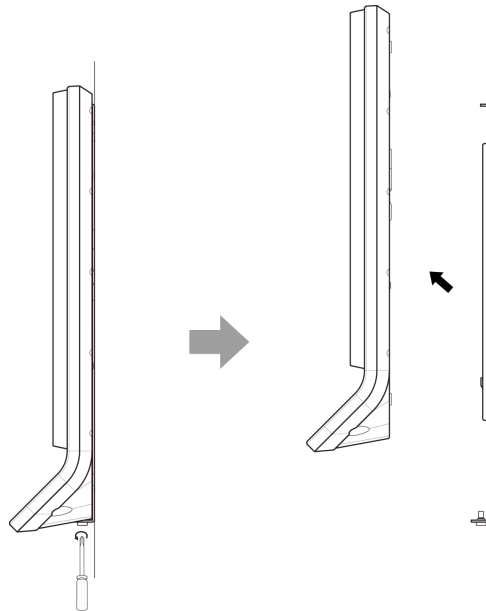

- 2 Loosen the fixing screws to separate the bracket from the wall.

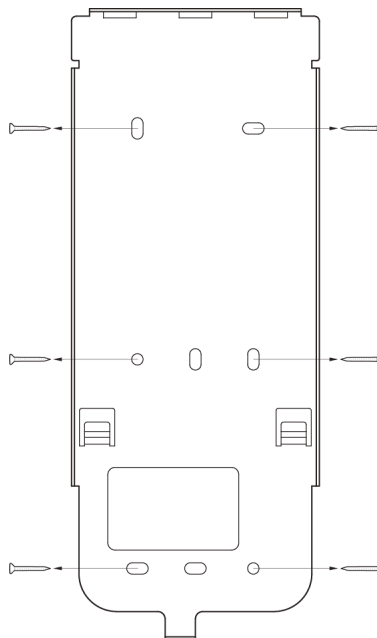

- 3 Fix the thermal camera module bracket firmly using fixing screws to the position where FaceStation F2 will be installed.

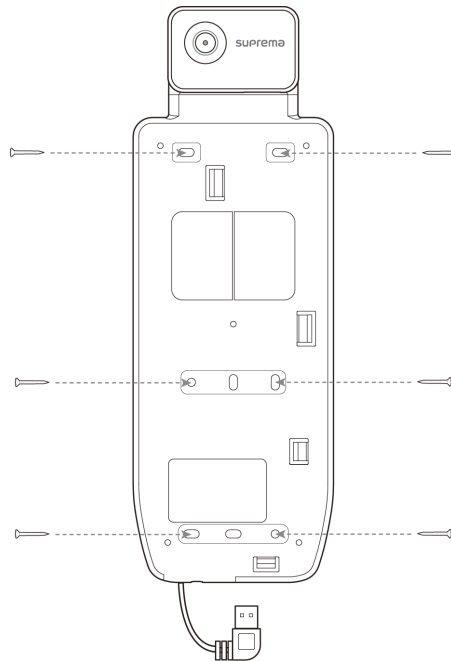
**NOTE**

- If installing FaceStation F2 on a concrete wall, drill holes, insert PVC anchors, and fix them with fixing screws.
- Install the device where it does not reach the direct sunlight.
- Do not install the device where the subject is backlit.
- For accurate temperature measurement, it is recommended to install the device indoors and to avoid installing it near air conditioners or heaters that can affect the ambient temperature.
- Install Suprema Thermal Camera in a stable ambient temperature environment that is not subject to bright lights in the camera's field of view. Suprema Thermal Camera may detect objects other than the intended subject if they are in the field of view of the camera, so the presence of other objects especially with elevated temperatures should be avoided.
- The device may be affected by the surrounding environment, such as sunlight, wind, or ambient temperature fluctuations. This may cause variations between the temperature measured by the device and actual skin temperature of the user.
- Warm up Suprema Thermal Camera for more than 90 minutes after turning it on for self-calibration.

- 4** Fasten the thermal camera module bracket with the FaceStation F2 bracket by using bracket fixing screws contained in the package.

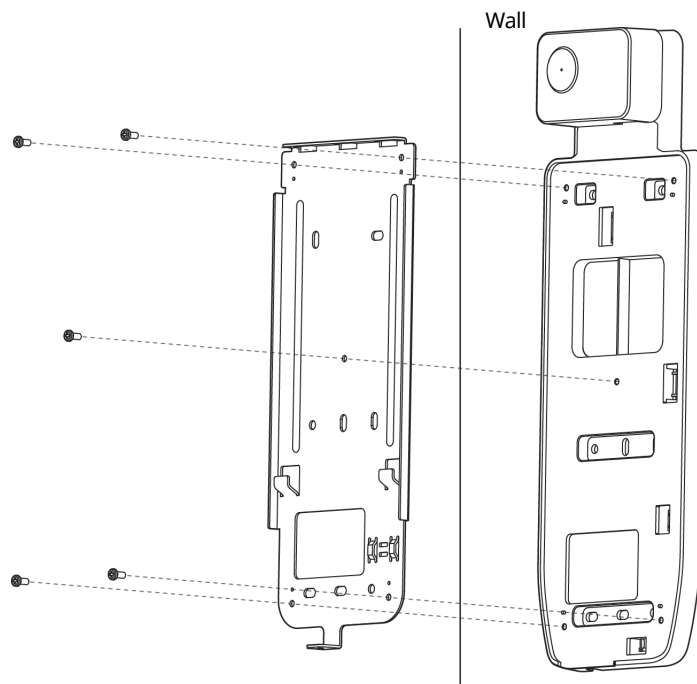

- 5** Install FaceStation F2 onto the fixed bracket.

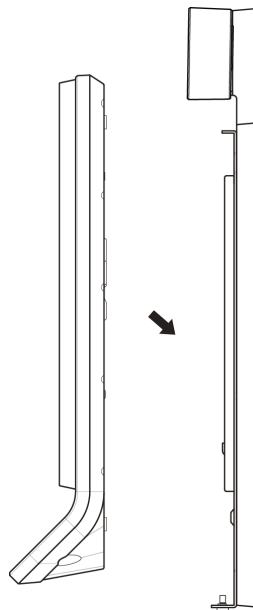

- 6** Connect FaceStation F2 to the bracket by rotating the product fixing screw of FaceStation F2.

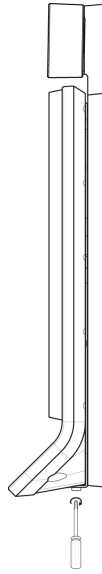

- 7** Connect the USB cable of the module to the connector of FaceStation F2.

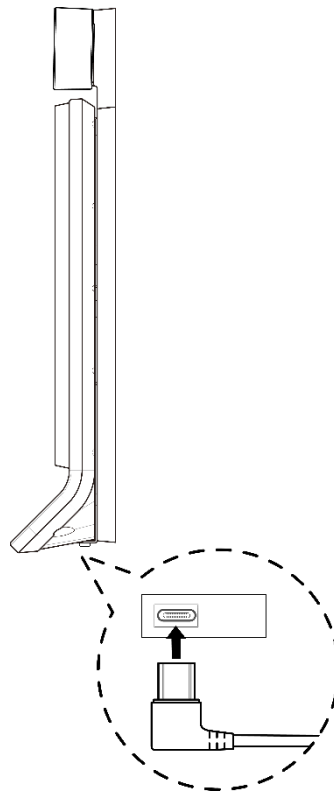

Installing Suprema Thermal Camera on a new FaceStation F2

- 1 Determine the correct position to install the product using the provided drilling template.

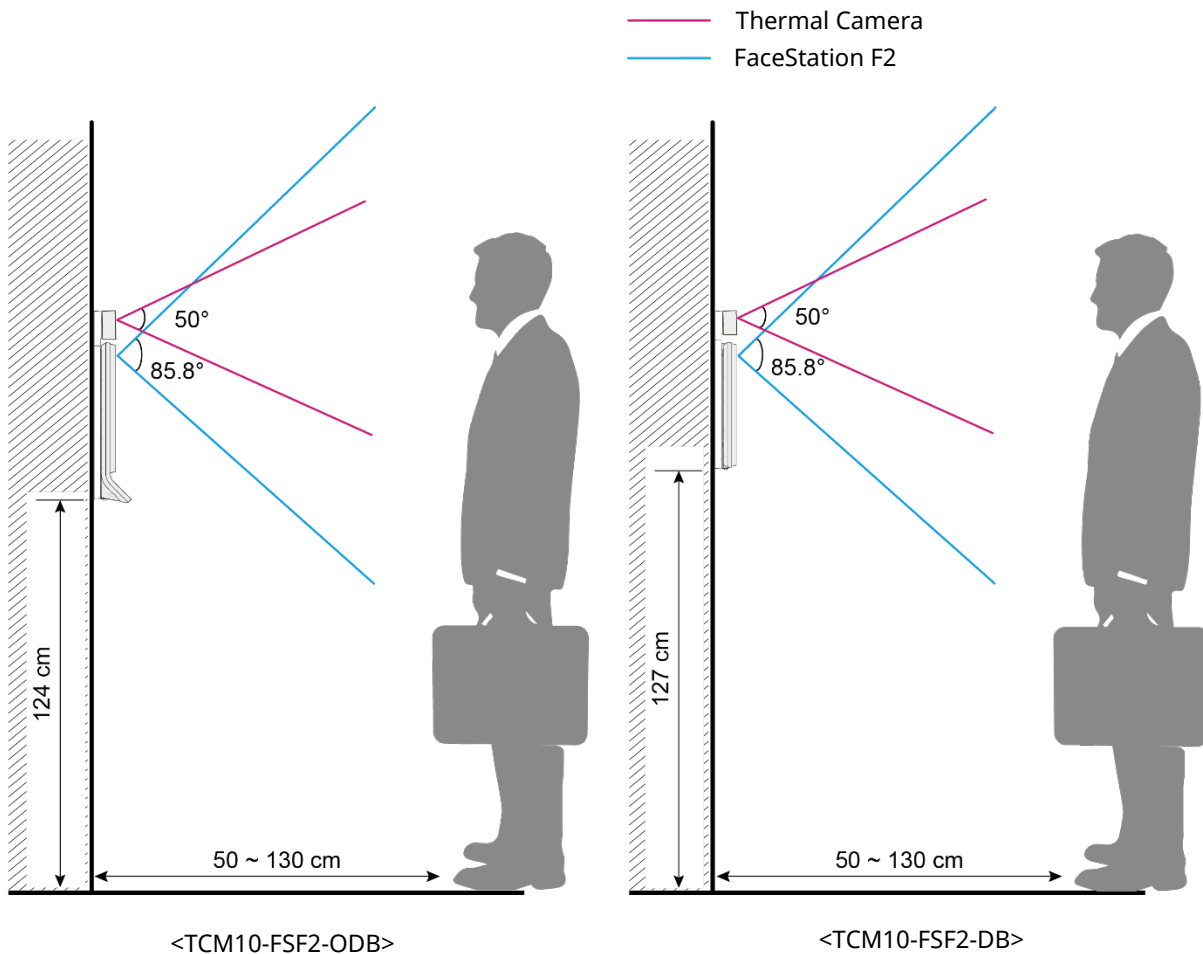

NOTE

- The optimal height for installing a device:
 - FSF2-ODB: 124 cm
 - FSF2-DB: 127 cm
- For accurate temperature detection, locate your face within the thermal camera's field of view and maintain the distance between 50 cm to 100 cm.
- Install the device where it does not reach the direct sunlight.
- Adjust the installation position so that the face is not exposed to direct sunlight when a user tries to authenticate.
- If installing FaceStation F2 on a concrete wall, drill holes, insert PVC anchors, and fix them with fixing screws.
- Do not install the device where the subject is backlit.
- For accurate temperature measurement, it is recommended to install the device indoors and to avoid installing it near air conditioners or heaters that can affect the ambient temperature.
- Install Suprema Thermal Camera in a stable ambient temperature environment that is not subject to bright lights in the camera's field of view. Suprema Thermal Camera may detect objects other than the intended subject if they are in the field of view of the camera, so the presence of other objects especially with elevated temperatures should be avoided.
- The device may be affected by the surrounding environment, such as sunlight, wind, or ambient temperature fluctuations. This may cause variations between the temperature measured by the device and actual skin temperature of the user.
- Warm up Suprema Thermal Camera for more than 90 minutes after turning it on for self-calibration.

2 Fix the thermal camera module bracket firmly using fixing screws to the position where FaceStation F2 will be installed.

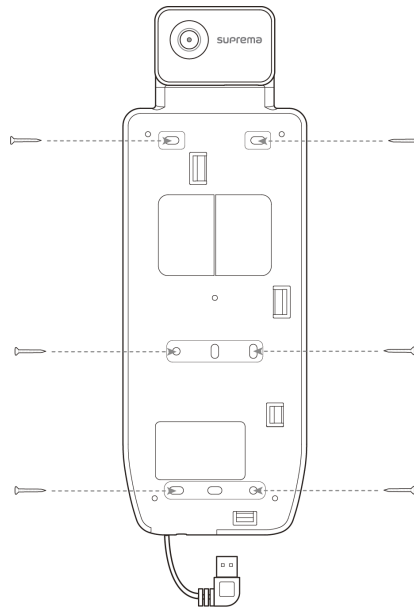

NOTE

- If installing FaceStation F2 on a concrete wall, drill holes, insert PVC anchors, and fix them with fixing screws.
- To avoid RF interference, a minimum separation distance must be maintained.

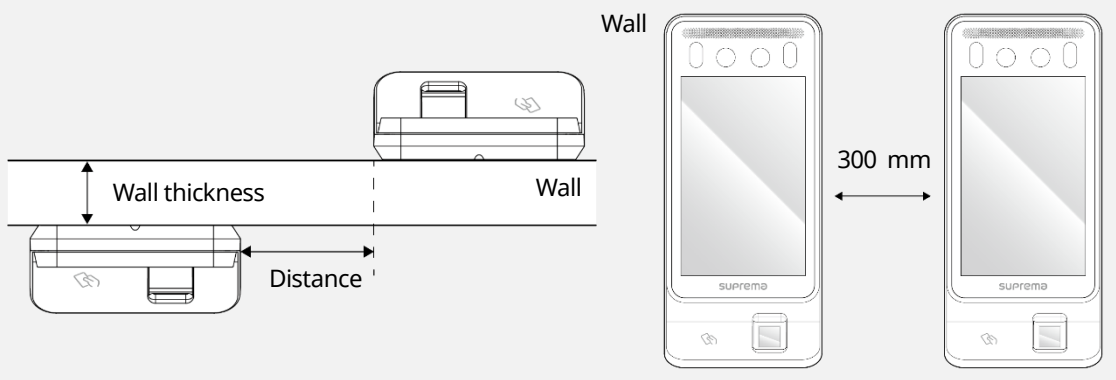

Wall thickness	Distance
100 mm	200 mm
120 mm	180 mm
150 mm	150 mm

- When using Suprema Mobile Access, install a minimum distance of 1 m between devices to avoid BLE interference.

- 3** Fasten the thermal camera module bracket with the FaceStation F2 bracket by using bracket fixing screws contained in the package.

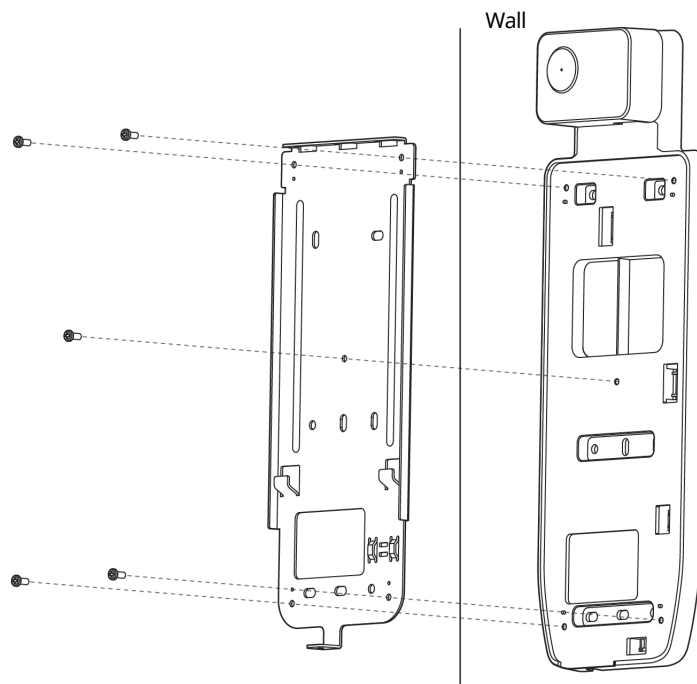

- 4** Install FaceStation F2 onto the fixed bracket.

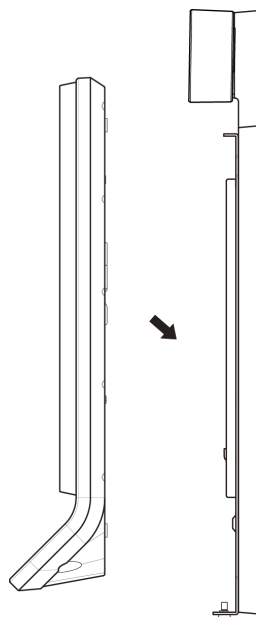

- 5 Connect FaceStation F2 to the bracket by rotating the product fixing screw of FaceStation F2.

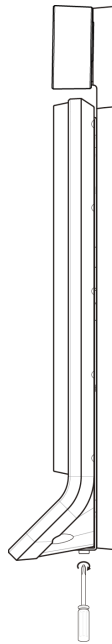

- 6 Connect the USB cable of the module to the connector of FaceStation F2.

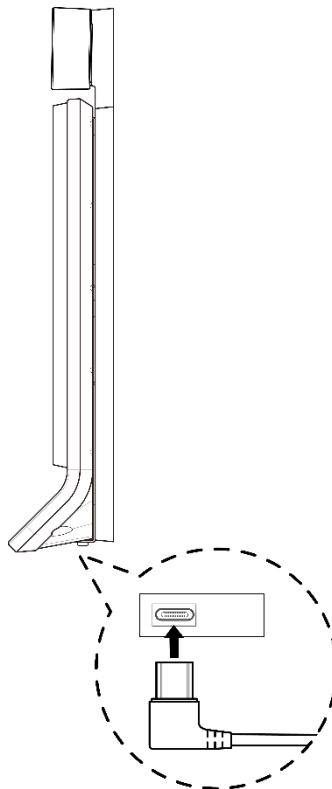
**NOTE**

- To learn how to wire the FaceStation F2, visit the Suprema website (www.supremainc.com) and refer to the installation manual.
- For more information, contact the Suprema technical support team (support.supremainc.com).

Settings

You can set up Suprema Thermal Camera in **AUTHENTICATION** menu of FaceStation F2.

- 1 Press  and authenticate with the Admin level credential.
- 2 Press **AUTHENTICATION > Face > Advanced Settings**.
- 3 Set **Check Mode** depending on the usage.
 - **Check After Authentication:** Measure the temperature after a successful authentication.
 - **Check Before Authentication:** Authenticate only when the user is within the range of the preset temperature threshold. When this mode is activated, it does not attempt to authenticate user's identity if their temperature has been detected to be above the threshold.
 - **Check Only:** Detect temperature without authentication. This mode allows users within the range of the preset threshold to access without checking their identity or access rights.
- 4 Set **Authentication Fail Sound** depending on the usage. You can set the alarm to trigger when the measured temperature is higher than preset threshold.
- 5 Press **Thermal Camera** and set the thermal camera options.
 - **Disabled:** The thermal camera is disabled.
 - **Enabled (Hard):** It refuses authentication of users with elevated temperature than of the preset threshold range and saves event logs.
 - **Enabled (Soft):** Users with elevated temperature than the preset threshold range can authenticate but event logs still be saved.
- 6 When Thermal Camera is enabled, you can set advanced settings. Change the desired item.
 - **Celsius/Fahrenheit:** Change the unit of temperature.
 - **Low Threshold Temperature:** Set the minimum threshold temperature to limit the access. Users with detected temperature below the threshold will be denied access. It can be set between 1°C to 45°C and cannot be higher than the value of the maximum threshold temperature.
 - **High Threshold Temperature:** Set the maximum threshold temperature to limit the access. Users with detected temperature over the threshold will be denied access. It can be set between 1°C to 45°C and cannot be higher than the value of the minimum threshold temperature.
 - **Save Temperature Data:** Save temperature data. When this mode is activated, it saves both authentication and temperature logs. When this mode is deactivated, it only saves authentication logs.
 - **Show Thermal Infrared Image:** Display infrared imaging on the screen of the devices.
 - **Dynamic ROI:** If there are ambient light sources near the device, the thermal camera may incorrectly measure the subject's temperature. You can set the thermal camera to automatically measure the skin temperature by detecting the ROI (Region of Interest) and to avoid detecting the temperature of ambient light devices.
 - **Camera Configuration:** Configure the thermal camera settings for accurate measurement.
 - **Distance(cm):** Set up the distance between the user and device.
 - **Emissivity:** Set up the emissivity to precisely measure the temperature of the user.
 - **ROI X(%), ROI Y(%), ROI Width(%), ROI Height(%):** If there are lights in the device field of view they may be detected instead of the desired subject. Set the temperature measurement area by adjusting the size and position of ROI (Region of Interest).
 - **Skin Temperature Compensation:** You can set the thermal camera to adjust its temperature value automatically measuring the ambient conditions.
 - **Skin Temperature Correction:** You can set the thermal camera to compensate for variations in caused by the ambient environment that consistently affect temperature measurement. For example, if the environment is causing temperature to be measured at 0.1°C higher, set the temperature correction to -0.1.
 - **FW:** It shows the current firmware version of the thermal camera when it is connected properly.

NOTE

- It is recommended to maintain the default values of the camera configuration settings for the best performance. The default values of each option are as follows:
 - **Distance(cm):** 100
 - **Emissivity:** 0.98
 - **ROI X(%):** 30
 - **ROI Y(%):** 25
 - **ROI Width(%):** 50
 - **ROI Height(%):** 55

Troubleshooting

Checklist before reporting a failure

Classification	Problem	Solution
Temperature measurement	Mask Detection is enabled, but face authentication can not be done smoothly when wearing a mask.	<ul style="list-style-type: none"> Authenticate your face twice with the mask pull down on the tip of your nose. Then, authenticate your face again wearing a mask that covers your nose completely. If the problem persists, contact the installation company.
	The thermal camera fails to measure temperature.	<ul style="list-style-type: none"> Check if the thermal camera is properly connected to the terminal. Measure the temperature again without covering your forehead. If the problem persists, contact the installation company.
	The thermal camera measures lower temperature than actual temperature.	<ul style="list-style-type: none"> If a user measures the temperature after being exposed to cold temperatures for a long time, the temperature may be measured lower than actual temperature. Wait for 1 to 2 minutes indoors and try again. If the problem persists, contact the installation company.

Product specifications*

Category	Feature	Specification
Thermal Module	Max. Resolution	120 × 160
	NETD (Noise Equivalent Temperature Difference)	≤ 50 mK (@25°C, F# = 1.0)
	Field of View	37.2° × 50° (H × V)
Temperature Measurement	Temperature Range	1°C to 45°C (33.8°F to 113°F)
	Temperature Accuracy	± 0.5°C (0.9°F)* / ±0.3°C (0.5°F)**
	Temperature Distance	Adjustable, 50 cm-100 cm (19.69" to 39.37")
General	Dimension (W x H x D)	<ul style="list-style-type: none"> • Camera: 77 mm x 46 mm x 22.2 mm (3.03" x 1.81" x 0.87") • Camera with bracket: <ul style="list-style-type: none"> - TCM10-FSF2-ODB: 109.89 mm x 315.69 mm x 13 mm (4.33" x 12.43" x 0.51") - TCM10-FSF2-DB: 109.89 mm x 283.39 mm x 13 mm (4.33" x 11.16" x 0.51")
	Interface	USB
	Operating Temperature	0°C to 50°C (32°F to 122°F)
	Storage Temperature	-40°C to 60°C (-40°F to 140°F)
	Operating Humidity	5% to 85%

* This document only provides the specifications of Suprema Thermal Camera. To check the specification of FaceStation F2, refer to the user manual.

* This accuracy rate is possible only when you use the device under the following conditions:

- 1) Warm up Suprema Thermal Camera for more than 90 minutes after turning it on for self-calibration.
- 2) Operate the device within the recommended ambient temperature range (10°C to 35°C or 50°F to 95°F).

** According to KOLAS (Korea Laboratory Accreditation Scheme) calibration certificate

Dimensions

(Unit: mm)

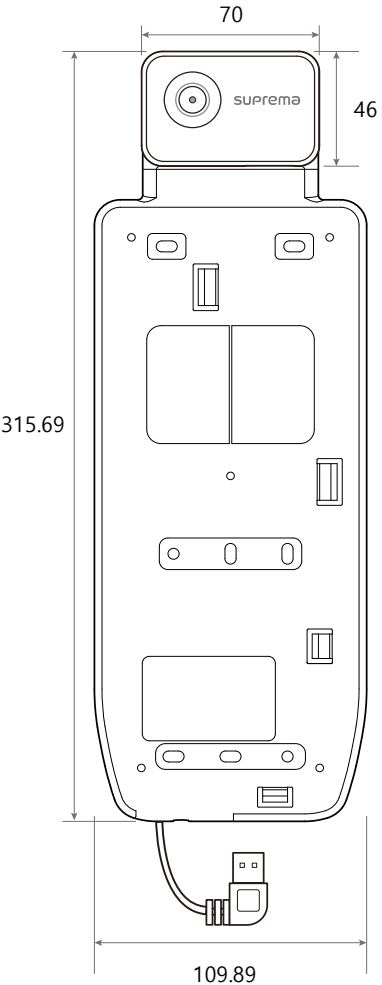

<TCM10-FSF2-ODB>

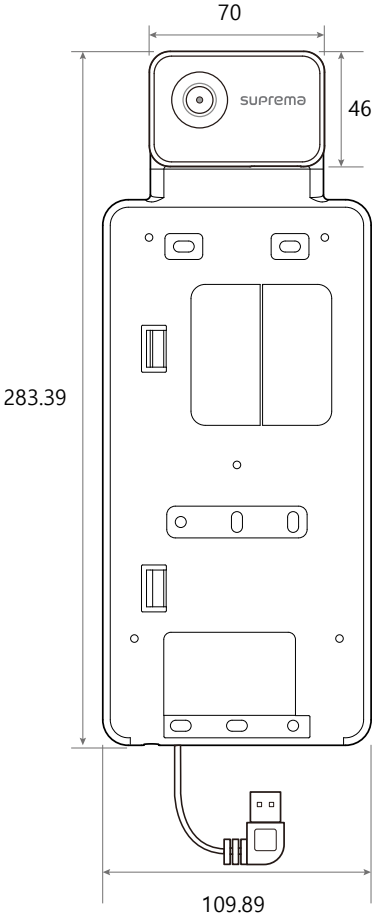

<TCM10-FSF2-DB>

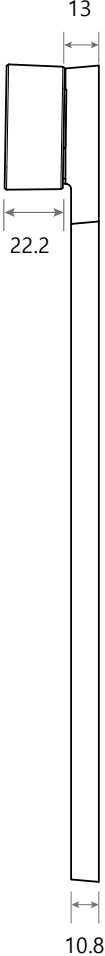

10.8

Appendices

Disclaimers

- The information in this manual is provided with regard to Suprema products.
- The right to use is acknowledged only for products included in the terms and conditions of the sales agreement guaranteed by Suprema. The right of license to other intellectual property rights not discussed in this manual is not acknowledged.
- Suprema does not guarantee or hold responsibility for the suitability and commerciality of the product for a specific purpose, or the infringement of patent, copyright, or other intellectual property rights with regard to sales or usage of Suprema products.
- Do not use a Suprema product in situations related to medical, rescue of human lives, or maintenance of life, as a person may be injured or killed due to product malfunction. If an accident occurs while a consumer is using the product under the situations described as examples above, employees, subsidiaries, branches, affiliated companies, and distributors of Suprema do not accept responsibility, nor will they be liable for all related direct and indirect expenses or expenditures, including attorney fees, even if the consumer has discovered shortcomings in the product design or manufacturing process and claims this as a significant fault.
- Suprema may modify the product size and specifications at any time without proper notice in order to improve the safety, function, and design of the product. Designers must keep in mind that functions or descriptions indicated as "to be implemented" or "undefined" may change at any time. Suprema will implement or define such functions or descriptions in the near future, and Suprema accepts no responsibility for compatibility issues and any other problems arising from such compatibility issues.
- Suprema products are not used to diagnose any medical conditions. Suprema thermal cameras can identify individuals with skin temperature higher than a preset figure but should not be solely or primarily relied upon to diagnose or exclude a diagnosis of COVID-19, or any other disease. Only a licensed medical professional can determine if a person with elevated skin temperature is symptomatic of a specific medical condition.
- If you wish to obtain the newest specifications before ordering the product, contact Suprema through a Sales Representative or local distributor of Suprema.

Copyright notice

The copyright of this document is vested in Suprema. The rights of other product names, trademarks, and registered trademarks are vested in each individual or organization that owns such rights.



Suprema Inc.

17F Parkview Tower, 248, Jeongjail-ro, Bundang-gu, Seongnam-si, Gyeonggi-do, 13554, Rep. of KOREA
Tel: +82 31 783 4502 | Fax: +82 31 783 4503 | Inquiry: sales_sys@supremainc.com



For more information about Suprema's global branch offices,
visit the webpage below by scanning the QR code.
<https://supremainc.com/en/about/global-office.asp>